

TOP VIEW

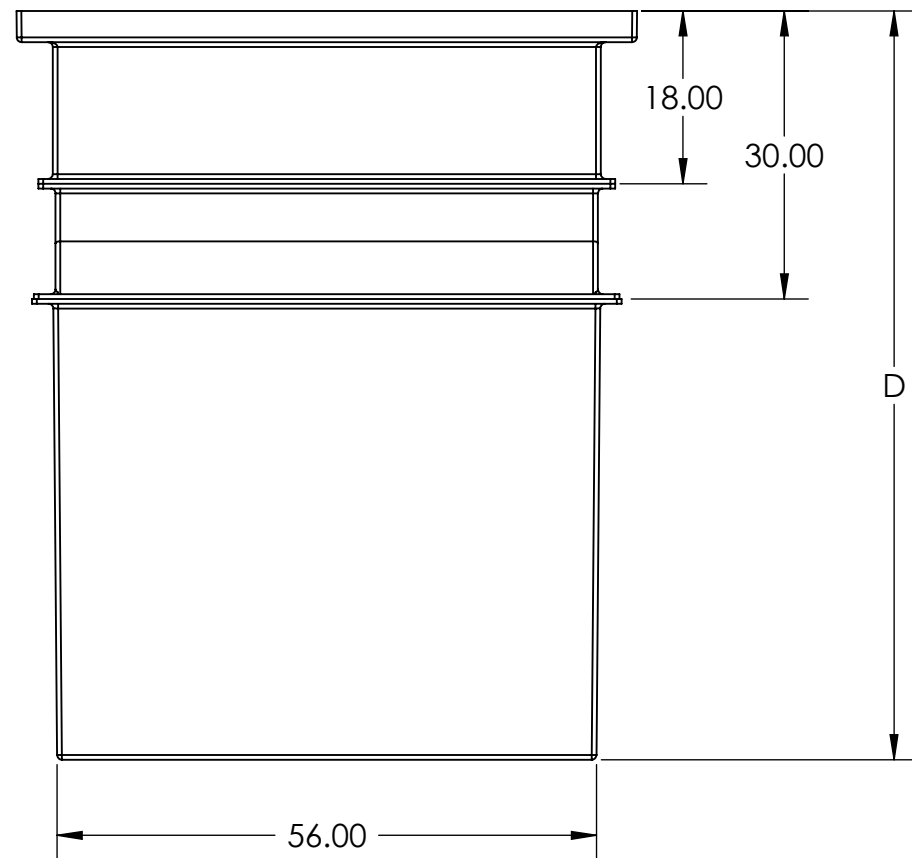

FRONT VIEW

.50 IN FIBERGLASS

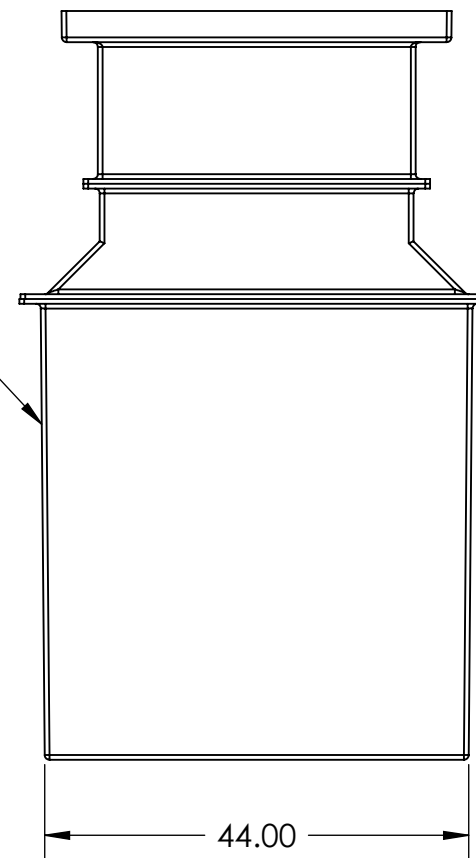

SIDE VIEW

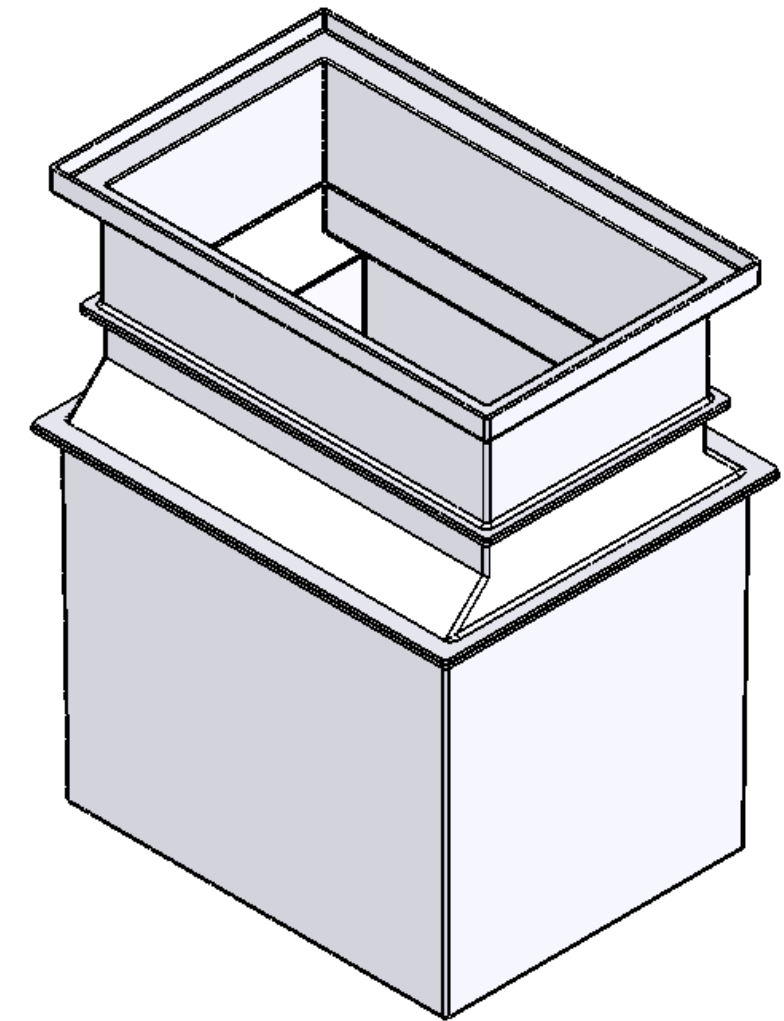

ISOMETRIC VIEW

STANDARD PITS	D
32X56-44X56-72D	72.00
32X56-44X56-84D	84.00
32X56-44X56-96D	96.00
32X56-44X56-108D	108.00
32X56-44X56-120D	120.00
CUSTOM DESIGNS AVAILABLE. CALL FOR DETAILS.	



APPROVALS	DATE
DRAWN DLL	11-26-07
CHECKED CDM	11-26-07
APPROVED CDM	11-26-07
SHEET 1 OF 1	
SCALE: 1:20	SIZE: B

**USS, INC.**  
 PHONE: (260) 693-1172 FAX: (260) 693-1178  
 WEB SITE: WWW.USSPECIALISTS.COM

**32X56-44X56**

**3 VIEW WITH ISO**

THE INFORMATION ON THIS DRAWING IS PROPRIETARY AND IS NOT TO BE REVEALED TO THIRD PARTIES WITHOUT WRITTEN CONSENT OF A CORPORATE OFFICER OF USS, INC.